

## INSTALLATION & MAINTENANCE GUIDE

**AMP**<sup>®</sup> Lighting

AMP<sup>®</sup> Low Voltage Landscape Lighting

AMP<sup>®</sup> G2 ControlPro Series

AAL-102X-4-B-BZ

Help Hotline:

1-813-978-3900 • Mon-Fri 9am-6pm (EST)

[www.amplighting.com](http://www.amplighting.com)



## Important Safety Instructions: Read Before Installation

This luminaire is intended for installation in accordance with local codes and the National Electric Code (NEC). Failure to adhere to these codes and instructions may result in serious injury, property damage and void the warranty.

These instructions do not intend to cover all variations in installation, operation maintenance or mounting situations.

1. Make sure the power is turned OFF before installing or servicing this luminaire.
2. **WARNING:** risk of electrical shock. Install all luminaires 10 feet (3.05M) or more from pool, spa or fountain.
3. This luminaire is intended to be used only with a power supply (transformer) rated maximum of 300 watts (25 AMPS) at 15 volts.
4. Wiring connections must be made with UL listed wire connectors that are suitable for outdoor use.
5. Position the low voltage wire and wire connector so that it is located within 6 inches (15.2 cm) from a building structure, a luminaire or fitting.
6. The main low voltage cable is intended for shallow burial - less than 6 inches (152 mm).
7. If additional lengths of low voltage cable are required, please contact [www.amplighting.com](http://www.amplighting.com) or call 1-813-978-3900.



## Important Safety Instructions

### INSTRUCTIONS PERTAINING TO A RISK OF FIRE, OR INJURY TO PERSONS

#### Lighted lamp is HOT!

**WARNING** - To reduce the risk of FIRE OR INJURY TO PERSONS.

1. Turn off/unplug and allow to cool before replacing lamp.
2. Lamp gets HOT quickly! Contact only switch/plug when turning on.
3. Do not touch the hot lens, guard or enclosure.
4. Keep lamp away from materials that may burn.
5. Do not touch lamp at any time. Use a soft cloth. Oil from skin may damage lamp.
6. Do not operate the luminaire fitting with a missing or damaged shield.

SAVE THESE INSTRUCTIONS

## Package Contents

- A. (1) Fixture
- B. (1) Stake

## Product Dimensions

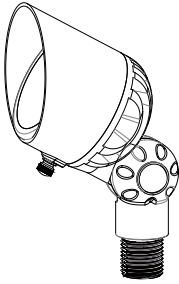
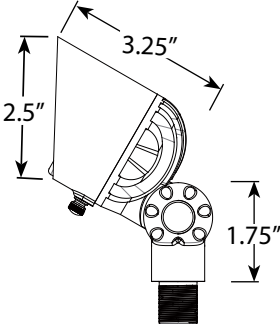

ControlPro 30

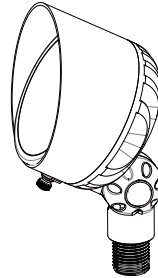
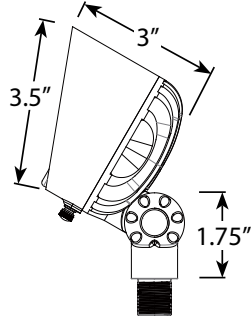

ControlPro 40  
ControlPro 60

## 1 Install Stake

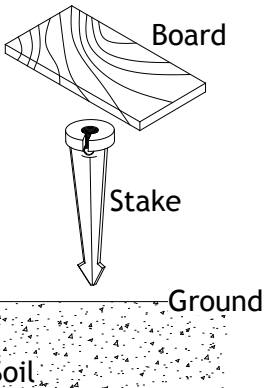

Determine the desired location for mounting the fixture. Hammer the stake into the ground until flange of stake is flush to grade. To avoid damage to the stake, place a board on top of the stake while hammering.

**NOTE:** If the ground is hard and the stake is difficult to install, make a crosscut in the ground using a flat shovel.

**2** Install Fixture to Stake

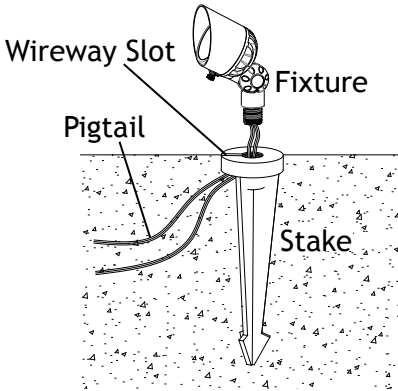

Clear away an area in the ground at the wireway slot on top of the stake. Lay the luminaire pigtail into the wireway slot and screw the fixture on to the stake. Tighten until snug.

**3** Wire Connection

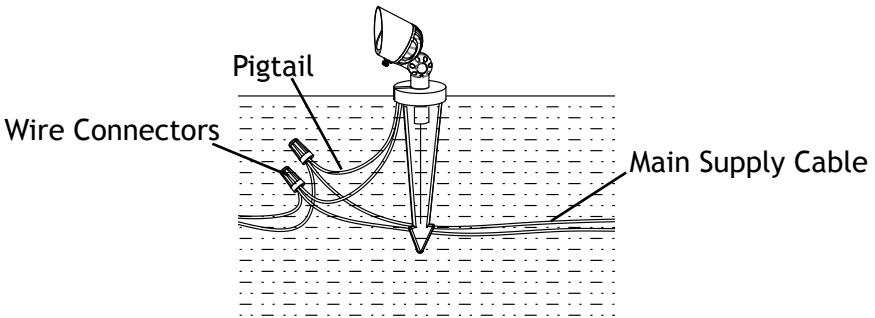

Strip both the leads from the luminaire pigtail. Using two wire connectors (sold separately), connect the leads from the luminaire to the main supply cable leads.

Install/Replace Optic

**4** Remove Glare Guard

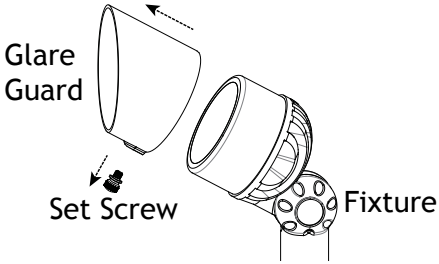

Loosen the set screw and remove the glare guard from the fixture.

**5** Remove Fixture Lens

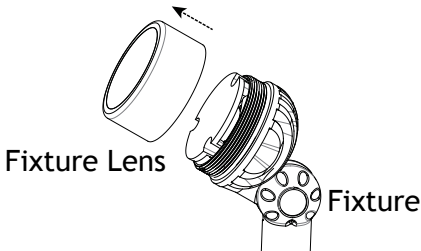

Loosen the fixture lens and remove it from the fixture.

**6** Remove Fixture Lens

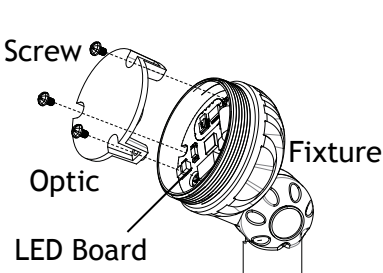

Loosen the screws and remove the optic from the fixture.

Install the new optic in the fixture and reverse Step 3 - Step 1. Make sure that you have the optic properly aligned over the LED board before tightening down. Improper alignment when tightening the screws can cause the optic to break.



AMP® G2 ControlPro Series  
AAL-102X-4-B-BZ



**AMP**<sup>®</sup> Lighting

**Help Hotline:**

**1-813-978-3900 • Mon-Fri 9am-6pm (EST)**

Specifications and product details subject to change without notice.  
© Copyright 2019, AMP<sup>®</sup> Lighting, Lutz FL USA 33549 • All rights reserved.  
customersupport@amplighting.com • 813.978.3900

**[www.amplighting.com](http://www.amplighting.com)**

IS-AAL-102X-4-B-BZ-ver1.pdf