

INSTALLATION & MAINTENANCE GUIDE

AMP[®] Lighting

AMP[®] Low Voltage Landscape Lighting

AMP[®] SleekPro MR11 Downlight (Lamp Ready)

AAL-1034-B-BZ

Help Hotline:

1-813-978-3900 • Mon-Fri 9am-6pm (EST)

www.amplighting.com



Important Safety Instructions: Read Before Installation

This luminaire is intended for installation in accordance with local codes and the National Electric Code (NEC). Failure to adhere to these codes and instructions may result in serious injury, property damage and void the warranty.

These instructions do not intend to cover all variations in installation, operation maintenance or mounting situations.

1. Make sure the power is turned OFF before installing or servicing this luminaire.
2. **WARNING:** risk of electrical shock. Install all luminaires 10 feet (3.05M) or more from pool, spa or fountain.
3. This luminaire is intended to be used only with a power supply (transformer) rated maximum of 300 watts (25 AMPS) at 15 volts.
4. Wiring connections must be made with UL listed wire connectors that are suitable for outdoor use.
5. Position the low voltage wire and UL listed wire connector so that it is located within 6 inches (15.2 cm) from a building structure, a luminaire or fitting.
6. The main low voltage cable is intended for shallow burial - less than 6 inches (152 mm).



Important Safety Instructions

INSTRUCTIONS PERTAINING TO A RISK OF FIRE, OR INJURY TO PERSONS Lighted lamp is HOT!

WARNING - To reduce the risk of FIRE OR INJURY TO PERSONS.

1. Turn off/unplug and allow to cool before replacing lamp.
2. Lamp gets HOT quickly! Contact only switch/plug when turning on.
3. Do not touch the hot lens, guard or enclosure.
4. Keep lamp away from materials that may burn.
5. Do not touch lamp at any time. Use a soft cloth. Oil from skin may damage lamp.
6. Do not operate the luminaire fitting with a missing or damaged shield.

SAVE THESE INSTRUCTIONS

Package Contents

- A. Fixture Body
- B. Tool

Parts Required (sold separately)

- A. Mounting Accessory
- B. (1) MR11 Bulb

Product Dimensions

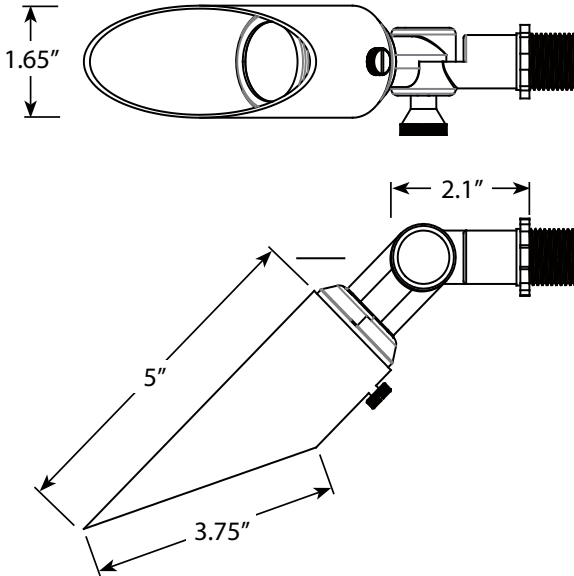

AMP[®] AMP[®] SleekPro MR11 Downlight (Lamp Ready) AAL-1034-B-BZ

1 Remove Glare Guard and Lens

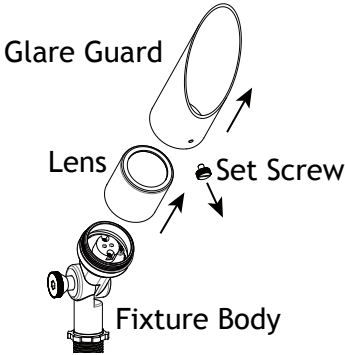

Loosen the set screw and remove the glare guard. Then twist and remove the lens from the fixture body.

2 Install MR11 Bulb

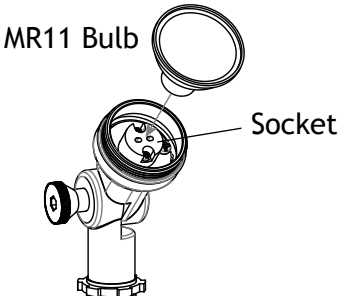

Insert the MR11 bulb with the correct wattage and type marked on the fixture label.

CAUTION: Do not exceed maximum wattage marked on luminaire label.

3 Install Lens and Glare Guard

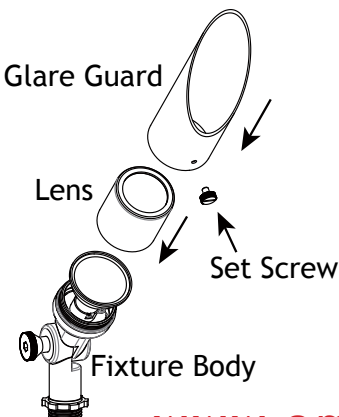

Thread the lens back onto the fixture body and hand tighten until snug.

Place the glare guard back onto the lens and secure by using the previously removed set screw.

4 Install Fixture Body to Mount

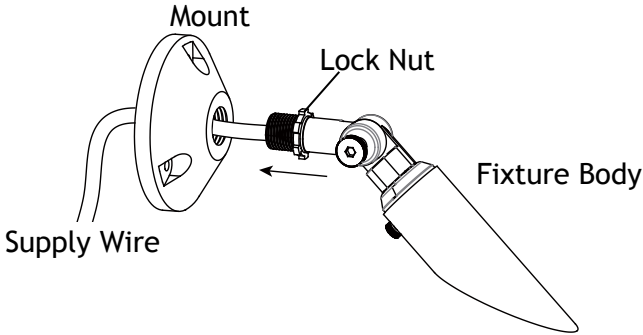

Pass the supply wire through the mount and thread the mount onto the fixture body.
Tighten the lock nut against the mount and hand tighten until snug.

5 Install Mount

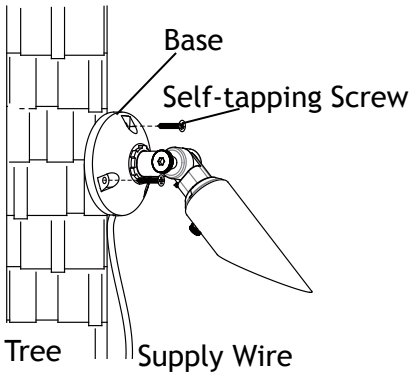

Attach the mount onto the surface using 3 self-tapping screws.



6 Wire Connections

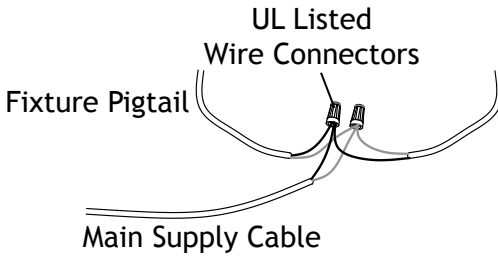

Strip both leads from the luminaire pigtail. Using two UL listed wire connectors (sold separately), connect the leads from the luminaire to the main supply cable leads.

7 Adjust Fixture Direction

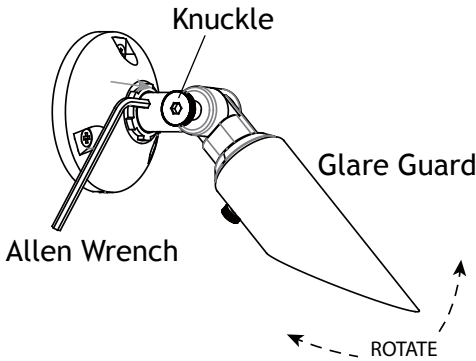

Using an Allen wrench, loosen the knuckle and adjust the fixture to your desired direction. Once your desired direction is achieved, tighten the knuckle to secure it in place.

Install/Replace Bulb

Remove the glare guard and the lens to expose the MR11 bulb and replace it with the correct wattage and type marked on the fixture label. Then, reinstall the lens and the glare guard.

IMPORTANT: MR11 bulb must be protected from moisture and dust at all times. Always reinstall the lens and the glare guard when removed.

AMP[®] Lighting

Help Hotline:

1-813-978-3900 • Mon-Fri 9am-6pm (EST)

Specifications and product details subject to change without notice.
© Copyright 2021, AMP[®] Lighting, Lutz FL USA 33549 • All rights reserved.
customersupport@amplighting.com • 813.978.3900

www.amplighting.com

IS-AAL-1035-B-BZ-ver1.pdf