

INSTALLATION & MAINTENANCE GUIDE

AMP[®] Lighting

AMP[®] Low Voltage Landscape Lighting

AMP[®] RenaissancePro Deck Light

ADL-2011-4-B-BZ

Help Hotline:

1-813-978-3900 • Mon-Fri 9am-6pm (EST)

www.amplighting.com



! Important Safety Instructions: Read Before Installation

This luminaire is intended for installation in accordance with local codes and the National Electric Code (NEC). Failure to adhere to these codes and instructions may result in serious injury, property damage and void the warranty.

These instructions do not intend to cover all variations in installation, operation maintenance or mounting situations.

1. Make sure the power is turned OFF before installing or servicing this luminaire.
2. **WARNING:** risk of electrical shock. Install all luminaires 10 feet (3.05M) or more from pool, spa or fountain.
3. This luminaire is intended to be used only with a power supply (transformer) rated maximum of 300 watts (25 AMPS) at 15 volts.
4. Wiring connections must be made with UL listed wire connectors that are suitable for outdoor use.
5. Position the low voltage wire and wire connector so that it is located within 6 inches (15.2 cm) from a building structure, a luminaire or fitting.
6. The main low voltage cable is intended for shallow burial - less than 6 inches (152 mm).
7. If additional lengths of low voltage cable are required, please contact www.amplighting.com or call 1-813-978-3900.

! Important Safety Instructions

INSTRUCTIONS PERTAINING TO A RISK OF FIRE, OR INJURY TO PERSONS
Lighted lamp is HOT!

WARNING - To reduce the risk of FIRE OR INJURY TO PERSONS.

1. Turn off/unplug and allow to cool before replacing lamp.
2. Lamp gets HOT quickly! Contact only switch/plug when turning on.
3. Do not touch the hot lens, guard or enclosure.
4. Keep lamp away from materials that may burn.
5. Do not touch lamp at any time. Use a soft cloth. Oil from skin may damage lamp.
6. Do not operate the luminaire fitting with a missing or damaged shield.

SAVE THESE INSTRUCTIONS

Package Contents

- A. (1) Fixture
- B. (2) Lock Screws

Parts Required

- A. (1) Lamp

Product Dimensions

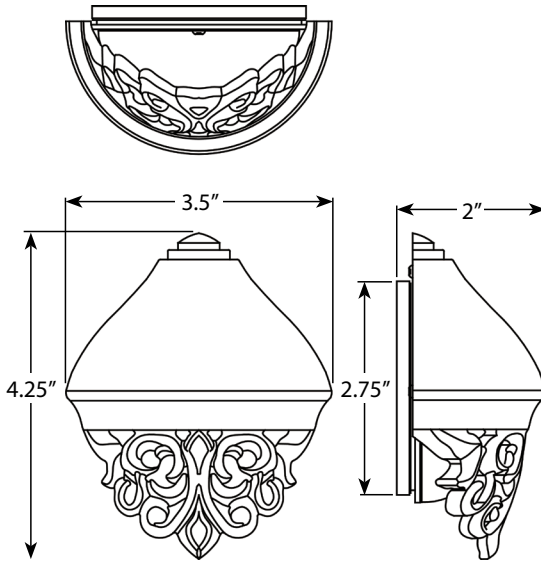

ProTip for Hiding Lead Wire

Determine the location for the fixture. Drill a hole straight through the desired mounting location and run the lead wire out the backside of the location so that the wires are not visible from the front side. Use a matching trim piece and cut a groove in the back of trim. Cover the lead wires with the matching trim piece.

ProTip for Hiding Splice Connections

All fixtures come with 4' of lead wire enabling you to hide the splice connections out of sight. If you must make a splice connection in view, use an inline heat shrink style connection that is less visible than traditional twist caps.

AMP® RenaissancePro Deck Light ADL-2011-4-B-BZ

1 Remove Face Cover

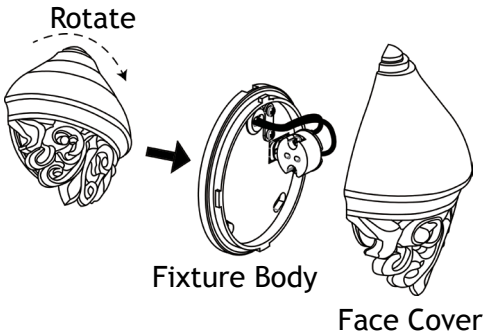

Rotate the face cover until it stops and then lift the cover straight off.

Note: The first time it may be difficult because the fixture has a very tight o-ring seal and a grease sealant for moisture protection.

2 Install Fixture Body

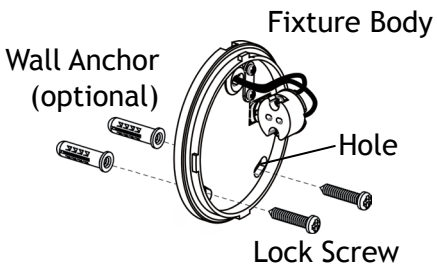

Attach the fixture body to your desired location and secure with lock screws.

Note: Wall anchors may be required for certain installation conditions (e.g. Brick walls, Concrete Walls, etc.). Mark on the wall using holes on the fixture body to drill holes for your wall anchors. Remove base and drill proper holes in the wall, then insert wall anchors.

3 Install Lamp

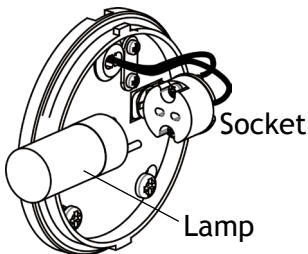

Insert lamp with the correct wattage and type marked on fixture label and push into place.

CAUTION: Do not exceed maximum wattage marked on luminaire label.

AMP® AMP® RenaissancePro Deck Light ADL-2011-4-B-BZ

4 Install Face Cover

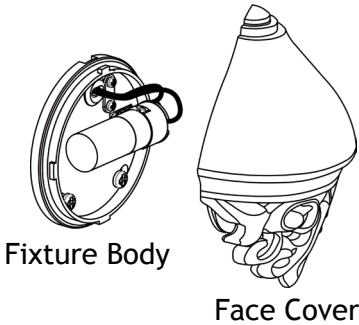

Push face cover back onto the fixture body aligned with the gaps in the fixture body. Once the face cover is flush with the fixture body, rotate the face cover until it stops and locks into place.

5 Wire Connections

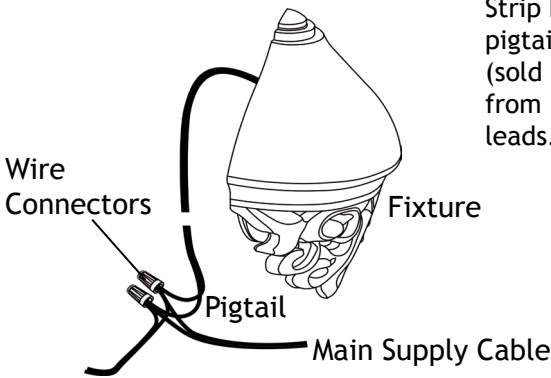

Strip both leads from luminaire pigtail. Using two wire connectors (sold separately), connect leads from luminaire to main supply cable leads.

Install/Replace Lamp

Rotate the face cover and remove it to expose the lamp. Replace it with the correct wattage and type marked on the fixture label. Then, reinstall the face cover.

IMPORTANT: Halogen bulbs must be protected from moisture and dust at all times. Always reinstall the face cover when removed.



Decorative Arms

Decorative arms are sold as additional options for this deck light. Please read the following steps for installation of the decorative arms.

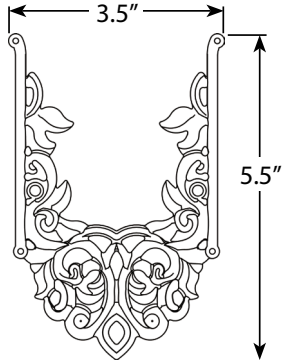

Install Decorative Arms

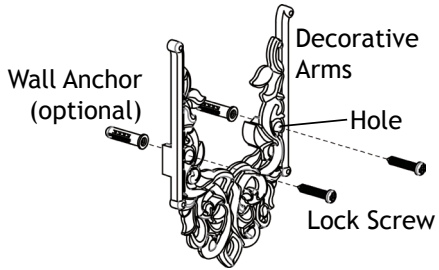
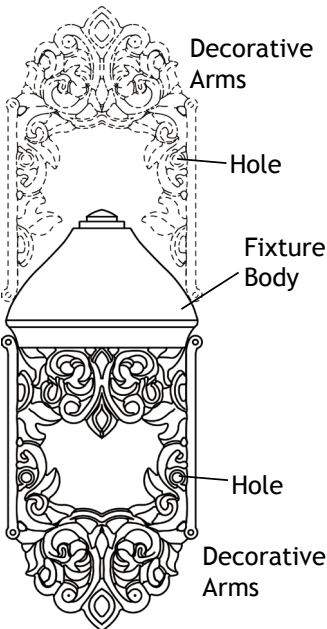

Attach the decorative arms on the top or bottom of the fixture body and secure with lock screws. Multiple decorative arms can be added going up or down to create your own unique look.

Note: Wall anchors may be required for certain installation conditions (e.g. Brick walls, Concrete Walls, etc.). Mark on the wall using holes on the fixture body to drill holes for your wall anchors. Remove base and drill proper holes in the wall, then insert wall anchors.

AMP[®] Lighting

Help Hotline:

1-813-978-3900 • Mon-Fri 9am-6pm (EST)

Specifications and product details subject to change without notice.
© Copyright 2019, AMP[®] Lighting, Lutz FL USA 33549 • All rights reserved.
customersupport@amplighting.com • 813.978.3900

www.amplighting.com

IS-ADL-2011-4-B-BZ-ver1.pdf