

INSTALLATION & MAINTENANCE GUIDE

AMP[®] Lighting

AMP[®] Low Voltage Landscape Lighting

AMP[®] BeaconPro Path & Area Light

APL-3030-4-B-BZ

Help Hotline:

1-813-978-3900 • Mon-Fri 9am-6pm (EST)

www.amplighting.com



Important Safety Instructions: Read Before Installation

This luminaire is intended for installation in accordance with local codes and the National Electric Code (NEC). Failure to adhere to these codes and instructions may result in serious injury, property damage and void the warranty.

These instructions do not intend to cover all variations in installation, operation maintenance or mounting situations.

1. Make sure the power is turned OFF before installing or servicing this luminaire.
2. **WARNING:** risk of electrical shock. Install all luminaires 10 feet (3.05M) or more from pool, spa or fountain.
3. This luminaire is intended to be used at 12V/AC.
4. Wiring connections must be made with UL listed wire connectors that are suitable for outdoor use.
5. Position the low voltage wire and UL listed wire connector so that it is located within 6 inches (15.2 cm) from a building structure, a luminaire or fitting.
6. The main low voltage cable is intended for shallow burial - less than 6 inches (152 mm).



Important Safety Instructions

INSTRUCTIONS PERTAINING TO A RISK OF FIRE, OR INJURY TO PERSONS

Lighted lamp is HOT!

WARNING - To reduce the risk of FIRE OR INJURY TO PERSONS.

1. Turn off/unplug and allow to cool before replacing lamp.
2. Lamp gets HOT quickly! Contact only switch/plug when turning on.
3. Do not touch the hot lens, guard or enclosure.
4. Keep lamp away from materials that may burn.
5. Do not touch lamp at any time. Use a soft cloth. Oil from skin may damage lamp.
6. Do not operate the luminaire fitting with a missing or damaged shield.

SAVE THESE INSTRUCTIONS

Package Contents

- A. (1) Fixture Body

Parts Required

- A. (1) Mounting Accessory
- B. (1) Flame Lamp
- C. (1) SCB Lamp (sold separately)

Product Dimensions

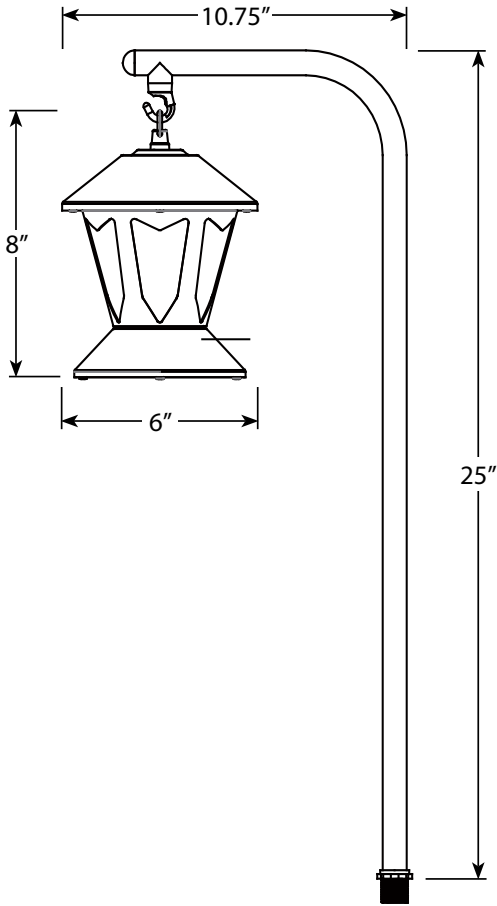

1 Remove Hat Bottom

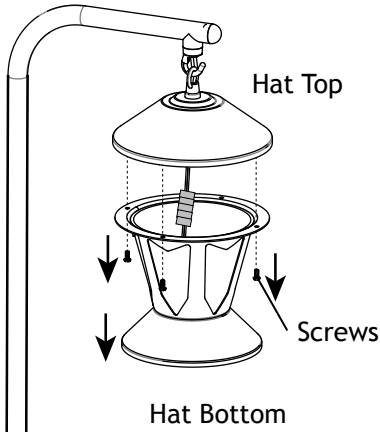

Remove the bottom of the hat, by using a screwdriver to loosen the screws.

2 Install Flame Lamp

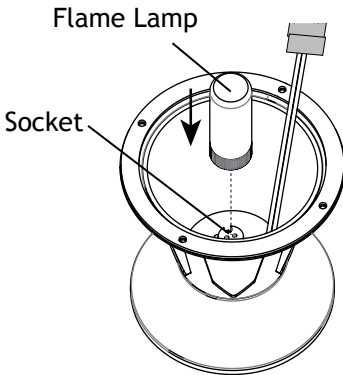

Install the flame lamp by aligning the line on the bottom of the lamp to the holes in the socket. Once it is aligned, gently push the flame lamp into the socket

CAUTION: Do not exceed maximum wattage marked on luminaire label.

3 Reinstall Hat Bottom

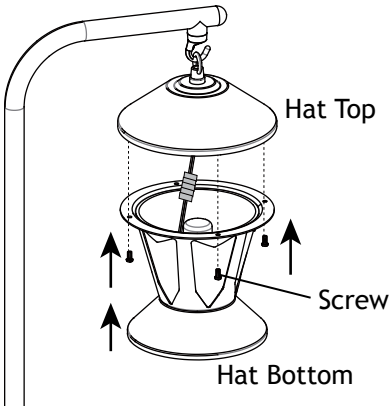

Reinstall the hat bottom using the previously removed screws. Use a screwdriver to make sure the screws are secure.

4 Remove Lens

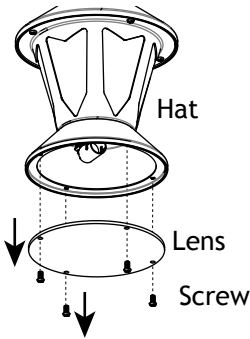

Remove the lens on the bottom of the hat by loosening the screws using a screwdriver.

5 Install SCB Lamp

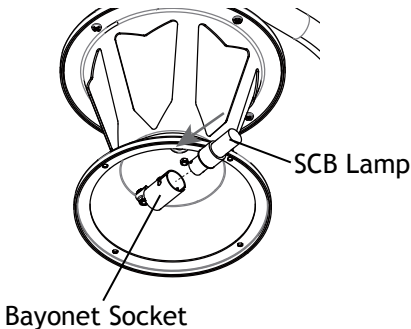

Use SCB lamp with correct wattage and type marked on fixture label.

Align the bayonet base of the SCB lamp to bayonet socket. Insert the SCB lamp into the bayonet socket and twist it until the SCB lamp is inserted properly.

CAUTION: Do not exceed maximum wattage marked on luminaire label.

AMP® AMP® BeaconPro Path & Area Light APL-3030-4-B-BZ

6 Reinstall Lens

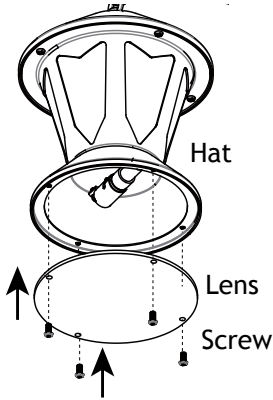

Place the lens back onto the bottom of the hat and use the previously removed screws to secure. Tighten with a screwdriver.

7 Install Stake

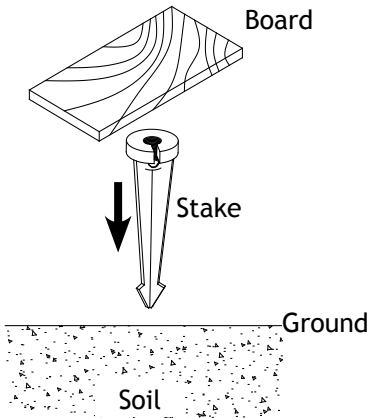

Determine the desired location for mounting the stake. Hammer the stake into the ground until flange of stake is flush to the ground. To avoid damage to the stake, place a board on top of the stake while hammering.

Note: If the ground is hard and the stake is difficult to install, make a crosscut in the ground using a flat shovel.

8 Install Fixture to Stake

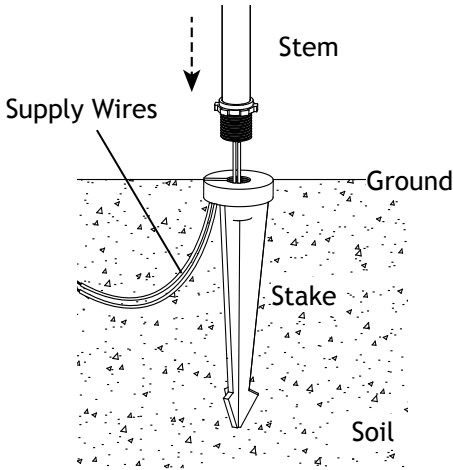

Pass supply wires through the open slot of the stake and thread the fixture onto the stake. Hand tighten until snug. Clear away area in ground and lay the supply wires into wireway slot.

9 Wire Connections

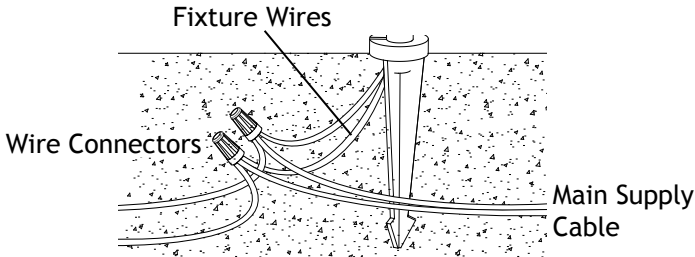

Strip both leads from fixture wires. Using two UL listed wire connectors (sold separately), connect the leads from fixture wires to main supply cable leads.

Install/Replace Lamp

Reverse Step 2 - Step 3 to replace the flame lamp. Then reinstall the bottom of the hat to protect the lamp. Reverse Step 5 - Step 6 to replace the SCB lamp. Reinstall the lens to protect the lamp.

IMPORTANT: Flame lamp and SCB lamp must be protected from moisture and dust at all times. Always reinstall the hat and lens when removed.

AMP[®] Lighting

Help Hotline:

1-813-978-3900 • Mon-Fri 9am-6pm (EST)

Specifications and product details subject to change without notice.
© Copyright 2021, AMP[®] Lighting, Lutz FL USA 33549 • All rights reserved.
customersupport@amplighting.com • 813.978.3900

www.amplighting.com

IS-APL-3030-4-B-BZ-ver1.pdf