

VOLT®

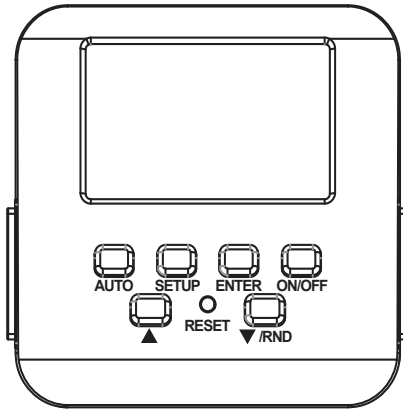

INSTALLATION INSTRUCTIONS

VOLT® DIGITAL TIMER

VOLT® G3 Astronomic Digital Timer

ITEM: VAC-DTIMER2-R1

1-813-978-3700 • Mon-Fri 8am-8pm • Sat-Sun 10am - 6pm (EST)

PRODUCT DIMENSIONS

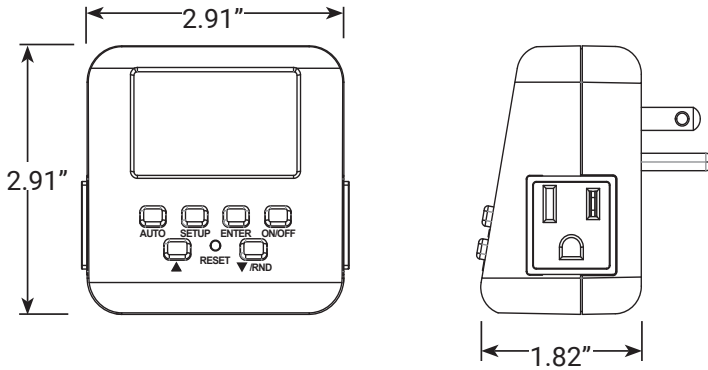

BUTTON DESCRIPTIONS

ON/OFF: Timer Override (Push to turn ON/OFF); if timer is currently on, it will be turned off; if timer is currently off, it will be turned on.

RESET: Push to clear all settings.

▼/RND: During normal program operation, push once to randomly, vary ON/OFF times within 2-30 minutes of programmed times.

▲ or ▼: Use during programming to scroll through menu options or increase and decrease time and date settings.

AUTO: Push when programming is complete to activate timer.

SETUP: Push to set Calendar/Clock/DST/Zone/Programming.

ENTER: Push to confirm menu selections during programming.

Note:

1. In the process of programming, long press the ▲ or ▼ buttons 2 seconds will active Quick Character Moving Functions (move 2 characters per second).
2. In the process of programming, if you do not press a button for 30 seconds, it will go back to the main screen (P12.1 or P12.2).
3. In the process of programming, press the **AUTO** button will go back to the main screen (P12.1 or P12.2) immediately.
4. All settings are saved by default, no matter returning back to the main screen automatically or manually.
5. External power supply detective function is reserved.

PROGRAMMING - SETTING THE CALENDAR, CLOCK, DST, ZONE

1. Use a tool to press the **RESET** button, and clear the program in the timer. When the reset button is released, the screen will be flashing 12:00 AM. Press the **SETUP** button to start settings.

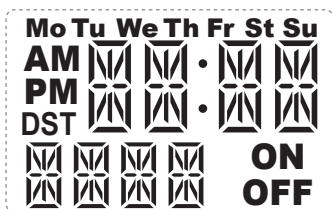

P1.1



P1.2

2. CAL will be flashing on the screen (Subjects can be changed among CAL-CLK-DST-ZONE-PROG by pressing the buttons ▲ or ▼ currently. Apply settings step by step for the first usage.). Press **ENTER** to begin setting the Calendar. The year will be flashing. Use the ▲ or ▼ buttons to select the year. Press **ENTER** to confirm the setting.



P2.1



P2.2

3. The month will be flashing. Use the ▲ or ▼ buttons to select the current month. Press **ENTER** to confirm the selection. The day will flashing. Use the ▲ or ▼ buttons to select the current day. Press **ENTER** to confirm the selection.



P3.1



P3.2

PROGRAMMING - SETTING THE CALENDAR, CLOCK, DST, ZONE (CONTINUED)

- The screen will be blinking CLK for Clock (Subjects can be changed among CAL-CLK-DST-ZONE-PROG by pressing the buttons ▲ or ▼ currently.). Press **ENTER** to begin setting the clock. The hour and AM or PM will be blinking. Use the ▲ or ▼ to select the correct hour. If you pass from 11 to 12, you will change the AM to PM or PM to AM. Once the correct hour is found, press **ENTER** to confirm the selection. The minutes will be blinking. Use the ▲ or ▼ to select the correct minute. Press



P4.1

ENTER →

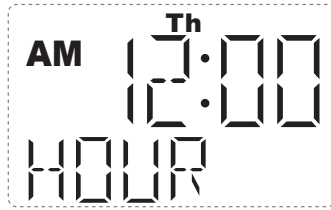

P4.2

↓ ENTER



P4.3

ENTER →

1. **ENTER** to confirm.
2. The screen will be blinking DST for “Daylight Savings Time” (Subjects can be changed among CAL-CLK-DST-ZONE-PROG by pressing the buttons ▲ or ▼ currently.). DST will automatically reset the times in the timer to match the time change. Press **ENTER** to select DST status.

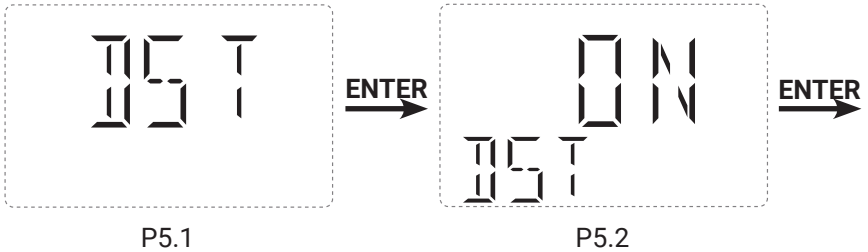

Use the ▲ or ▼ button to select the DST on or off and press **ENTER** to confirm the selection.

3. The screen should show the word ZONE blinking (Subjects can be changed among CAL-CLK-DST-ZONE-PROG by pressing the buttons ▲ or ▼ currently.). Press **ENTER** to select your ZONE. Look at the **Table 6.1.1** below and determine zone number of your location (For Example: Z01 — Alabama. Total 50 locations) . Use the ▲ or ▼ to scroll through the available zones in the timer, and stop when you find the zone which

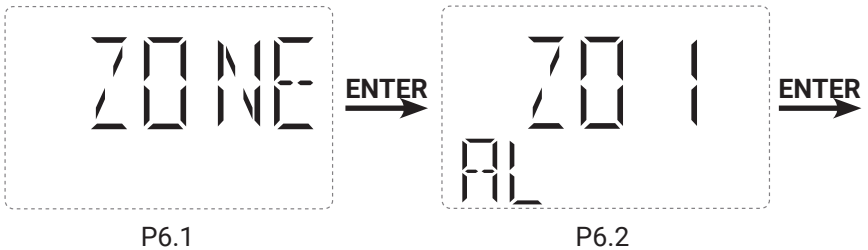

PROGRAMMING - SETTING THE CALENDAR, CLOCK, DST, ZONE (CONTINUED)

**Table 6.1.1
Zone Number & Location**

Zone No.	Location		Zone No.	Location	Abbr	Zone No.	Location	Abbr
Z01	Alabama	AL	Z18	Louisiana	LA	Z35	Ohio	OH
Z02	Alaska	AK	Z19	Maine	ME	Z36	Oklahoma	OK
Z03	Arizona	AZ	Z20	Maryland	MD	Z37	Oregon	OR
Z04	Arkansas	AR	Z21	Massachusetts	MA	Z38	Pennsylvania	PA
Z05	California	CA	Z22	Michigan	MI	Z39	Rhode Island	RI
Z06	Colorado	CO	Z23	Minnesota	MN	Z40	South Carolina	SC
Z07	Connecticut	CT	Z24	Mississippi	MS	Z41	South Dakota	SD
Z08	Delaware	DE	Z25	Missouri	MO	Z42	Tennessee	TN
Z09	Florida	FL	Z26	Montana	MT	Z43	Texas	TX
Z10	Georgia	GA	Z27	Nebraska	NE	Z44	Utah	UT
Z11	Hawaii	HI	Z28	Nevada	NV	Z45	Vermont	VT
Z12	Idaho	ID	Z29	New Hampshire	NH	Z46	Virginia	VA
Z13	Illinois	IL	Z30	New Jersey	NJ	Z47	Washington	WA
Z14	Indiana	IN	Z31	New Mexico	NM	Z48	West Virginia	WV
Z15	Iowa	IA	Z32	New York	NY	Z49	Wisconsin	WI
Z16	Kansas	KS	Z33	North Carolina	NC	Z50	Wyoming	WY
Z17	Kentucky	KY	Z34	North Dakota	ND			

PROGRAMMING - SETTING THE CALENDAR, CLOCK, DST, ZONE (CONTINUED)

1. describes the location where the timer is being installed. Press **ENTER** to confirm the selection.
2. The screen will show DAWN (sunrise) and a time with the hour blinking. This is the default time for Dawn. If the hour is not correct, use the ▲ or ▼ buttons to adjust the hour to match the correct time for your area. Once the hour is correct, press **ENTER** to confirm the selection. The minutes are now blinking. If the minutes are not correct, use the ▲ or ▼ buttons to adjust the minutes to match the correct time for your area. When the minutes are correct, press **ENTER** to confirm the selection.

The screen will now show DUSK (sunset) and a time with the hour blinking. This is the default time for DUSK. If the hour is not correct, use the ▲ or ▼ buttons to select the correct hour to match DUSK for you area. Press **ENTER** to confirm the hour. The minutes are now

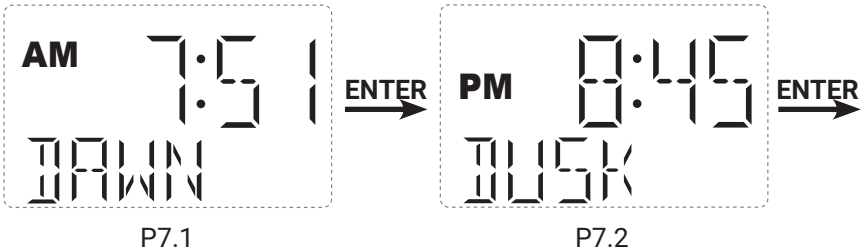

PROGRAMMING - SETTING THE PROG

blinking. If the minutes are not correct, use the ▲ or ▼ buttons to change the minutes to match DUSK for your area. Press **ENTER** to confirm the selection.

1. The screen will show PROG (Subjects can be changed among CAL-CLK-DST-ZONE-PROG by pressing the buttons ▲ or ▼ currently.). Press **ENTER** to begin setting the P1-ON. The P1 will be flashing. Press **ENTER**

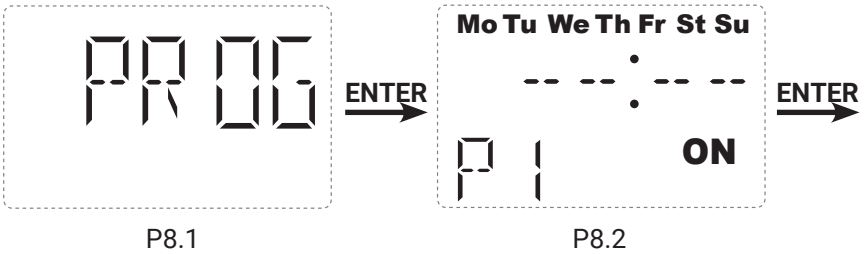

to begin setting P1-ON time, OR you may also use the ▲ or ▼ buttons to scroll any one of the 7 available programs (P1, P2, P3, P4, P5, P6, P7). Press **ENTER** to confirm.

2. If you push **ENTER** at SET for P1, the screen will show P1-ON, and the days of the week will be blinking. Use the or buttons to scroll through the options in which the timer will be active. The options are:

Mo, Tu, We, Th, Fr, St, Su (default)
 Individual days (choose a single day)
 Mo, We, Fr
 Tu, Th, St
 Mo, Tu, We, Th, Fr
 St, Su

Select the days you want the program to be active and press **ENTER** to confirm the selection.

3. Now that you have chosen the days, and go to choose the time. The screen should show DAWN blinking. Use the ▲ or ▼ to scroll through the

PROGRAMMING - SETTING THE PROG (CONTINUED)

1. three switching time options which are DAWN, DUSK (the programmed times selected during the timer setup), TIME (to set custom times) or



P10.1

BLANK (to cancel the current settings).

- i. (Option A) If you would like the timer to turn on at the preset time for



P10.2

- ii. DAWN, press **ENTER** to move to the P1-OFF setting.
- ii. (Option B) If you would like the timer to turn on at the preset time for DUSK, use the ▲ or ▼ buttons to change the option on the screen to DUSK, and press **ENTER**, to move to the P1-OFF setting.
- iii. (Option C) If you would like to choose a custom time other than DAWN or DUSK, use the ▲ or ▼ buttons to change the option on the screen to TIME, and press **ENTER**. The hour should be blinking. Use the ▲ or ▼ buttons to set the correct hour. If you pass the 11 to

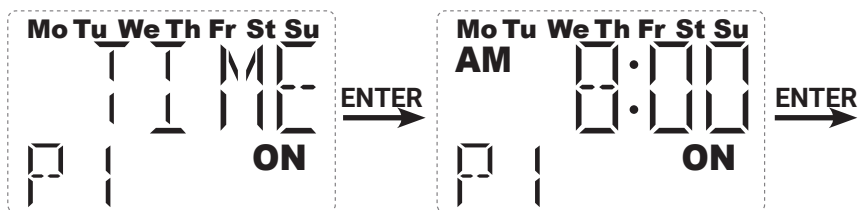

P10.3.1

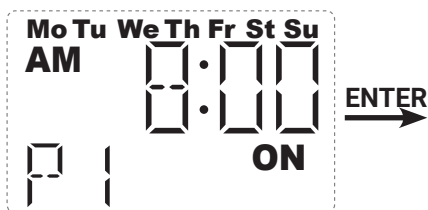

P10.3.2

PROGRAMMING - SETTING THE PROG (CONTINUED)

- i. 12, you will change the AM to PM. Once the correct hour is selected, press **ENTER** to confirm. The minutes will be blinking. Use the ▲ or ▼ buttons to set the correct minute, then press **ENTER**, to move to the P1-OFF setting.

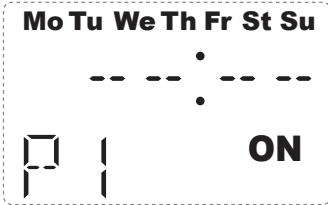

P10.4

- ii. (Option D) If you would like to cancel the current settings, choose the BLANK other than DAWN, DUSK and TIME, and press **ENTER**. It will go to the following screen. By pressing the ▲ or ▼ buttons to the next programming settings.
1. Now the screen will show the step is to choose the time the program will turn off. Use the ▲ or ▼ buttons to scroll through the 4 options DAWN, DUSK, TIME or BLANK, and precede the same as you did for P1-ON (Refer to P10.1, P10.2, P10.3.1-P10.3.2 or P10.4).
 2. After programming the P1-OFF time, press **ENTER** to save P1 to the timer. P2-ON should be blinking. Press **ENTER** to proceed the same process as you did for P1-ON to begin setting P2-ON. You may also use

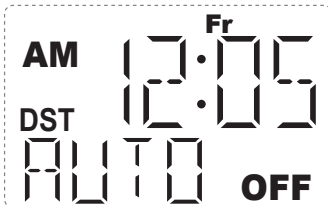

DST ON

P12.1

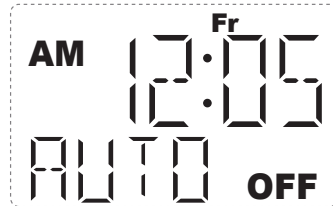

DST OFF

P12.2

the ▲ or ▼ buttons to scroll through all 7 programs, or push **AUTO** to complete the programming and return back to the main screen. (Note:

RANDOM SECURITY OPTION

1. DST will be shown on the screen if it was set up ON, or DST will not be shown. [Refer to P12.1 and P12.2])

Note: In the process of PROG settings, press **ON/OFF** button will cancel the current settings. Press it again to resume.

2. The random feature RND will delay turning the lights off. The delay of 2 to 30 minutes is randomly selected by the timer each day to give the house a more lived in appearance while the occupant is away.

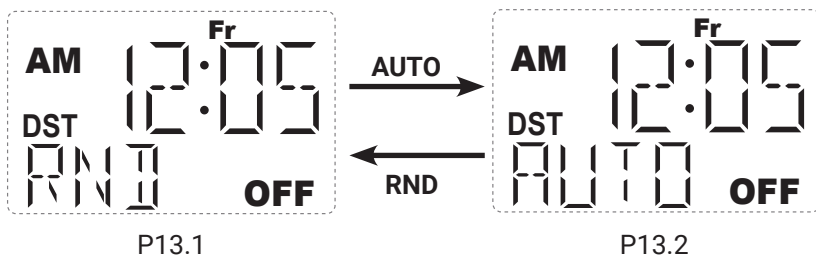

ASTRONOMICAL TIMER INSTRUCTIONS

After the time, date, location and dawn/dusk information is entered, this timer will automatically adapt to seasonal changes in daylight hours without reprogramming.

INSTALL TIMER TO TRANSFORMER

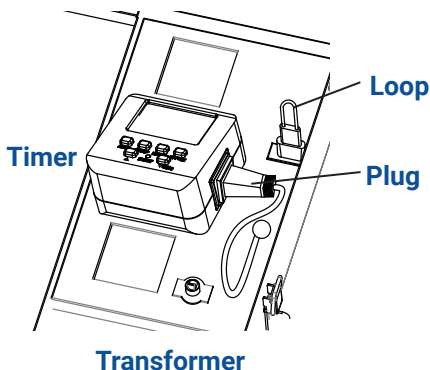

Plug the timer into the transformer. Then plug the plug of transformer into the socket of timer. Make sure the wire on the plug of transformer does not interfere with the loop when close the door.

VOLT®

1-813-978-3700 • Mon-Fri 8am-8pm • Sat-Sun 10am - 6pm (EST)

Specifications and product details subject to change without notice.
© Copyright 2023, VOLT® Lighting, Lutz FL USA 33549 • All rights reserved.
customersupport@voltlighting.com • www.voltlighting.com