

## INSTALLATION & MAINTENANCE GUIDE

**AMP<sup>®</sup>** Lighting

AMP<sup>®</sup> Low Voltage Landscape Lighting

AMP<sup>®</sup> 18" Hardscape Mounting Bracket - Stainless Steel  
VAC-HS-6718-YMP

**Help Hotline:**

1-813-978-3900 • Mon-Fri 9am-6pm (EST)

[www.amplighting.com](http://www.amplighting.com)

## INSTALLATION & MAINTENANCE GUIDE



AMP® 18" Hardscape Mounting Bracket - Stainless Steel  
VAC-HS-6718-YMP

### **! Important Safety Instructions: Read Before Installation**

This luminaire is intended for installation in accordance with local codes and the National Electric Code (NEC). Failure to adhere to these codes and instructions may result in serious injury, property damage and void the warranty.

These instructions do not intend to cover all variations in installation, operation maintenance or mounting situations.

1. Make sure that the power is turned OFF before installing or servicing this luminaire.
2. Warning: risk of electrical shock. Install all luminaires 10 feet (3.05M) or more from pool, spa or fountain.
3. This luminaire is intended to be used only with a power supply (transformer) rated maximum of 300 watts (25 AMPS) at 15 volts.
4. DO NOT INSTALL in walls where the capstones overhang the wall less than 3/4" [19mm] or under stairs where the tread overhangs the riser less than 3/4" (19mm).
5. Wiring connections must be made with UL listed wire connectors that is suitable for outdoor use.
6. Position the low voltage wire and UL listed wire connector so that it is located within 6 inches (15.2 cm) from a building structure, a luminaire, or fitting.
7. The main low voltage cable is intended for shallow burial - less than 6 inches (152 mm).

### Package Contents

- A. (1) Luminaire
- B. (2) Stainless Steel Screws

### Product Dimensions

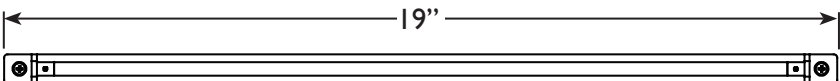

## INSTALLATION & MAINTENANCE GUIDE



AMP® 18" Hardscape Mounting Bracket - Stainless Steel  
VAC-HS-6718-YMP

### Optional: Install Glare Guard Before Installation

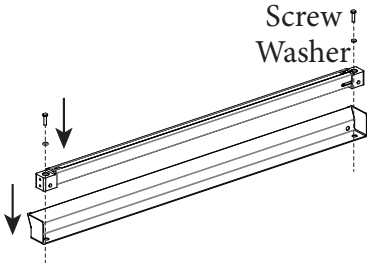

If you choose, you can attach the glare guard first before mounting the fixture.

Use the screws and washers to secure the glare guard onto the fixture. Tighten with a screwdriver.

### Install Luminaire to Y Bracket

#### 1 Determine Luminaire Location

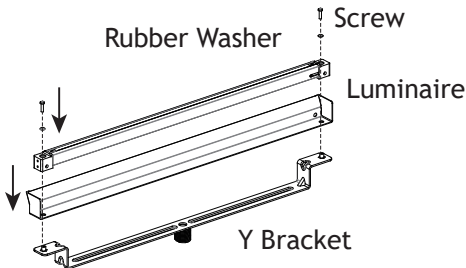

Place the luminaire onto the Y bracket using the rubber washers and screws. Tighten with a screwdriver.

**2** Install Riser

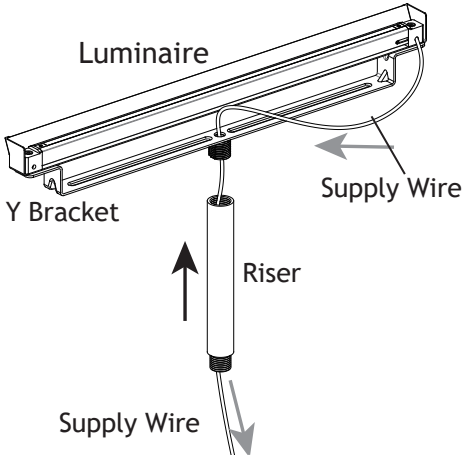

Pass the supply wire from the luminaire through the center hole on the Y bracket and the riser. Then thread the riser onto the Y bracket and hand tighten until snug.

**3** Install Stake

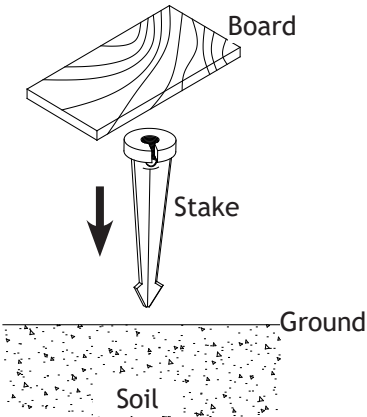

Determine the desired location for mounting the stake. Hammer the stake into the ground until flange of stake is flush to grade. To avoid damage to the stake, place a board on top of the stake while hammering.

Note: If the ground is hard and the stake is difficult to install, make a crosscut in the ground using a flat shovel.

**4** Install Riser to Stake

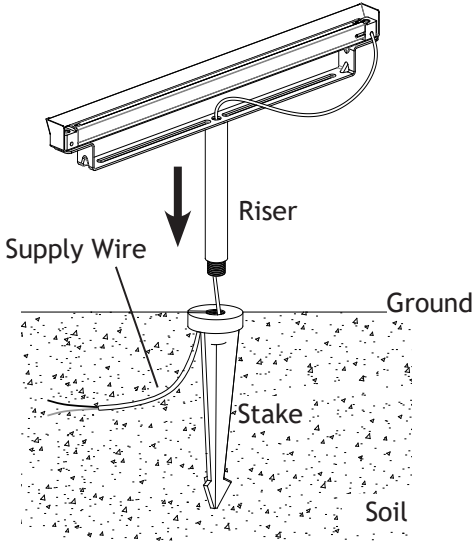

Clear away area in the ground at wireway slot on the top of the stake. Pass the fixture supply wire through the center hole of the stake and lay it into the wireway slots. Thread the riser onto the stake. Hand tighten until snug.

**5** Wire Connections

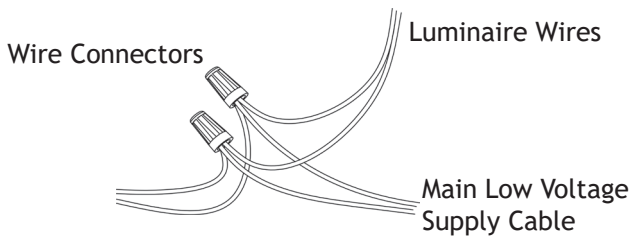

Strip both leads from the luminaire pigtail. Using two UL listed wire connectors (sold separately), connect the leads from the luminaire to the main supply cable leads.

*\* We recommend ace heat shrink style connectors for hardscape connections.*

**6** Adjust Lamp Direction

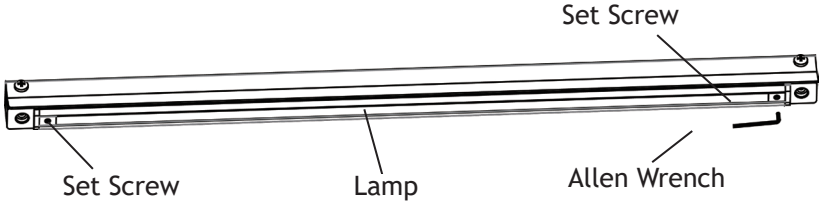

Using an Allen wrench, loosen the set screws on the ends of the lamp and then rotate the lamp to the desired direction. Always tighten the set screws after adjustments.

## INSTALLATION & MAINTENANCE GUIDE



AMP® 18" Hardscape Mounting Bracket - Stainless Steel  
VAC-HS-6718-YMP

**AMP**<sup>®</sup> Lighting

**Help Hotline:**

**1-813-978-3900 • Mon-Fri 9am-6pm (EST)**

Specifications and product details subject to change without notice.  
© Copyright 2021, AMP<sup>®</sup> Lighting, Lutz FL USA 33549 • All rights reserved.  
[customersupport@amplighting.com](mailto:customersupport@amplighting.com) • 813.978.3900