

INSTALLATION INSTRUCTIONS



VOLT® Low Voltage Landscape Lighting

VOLT® Glare Guards for Puck Lights (Bronze)

VAC-PK-GGX-BBZ

Help Hotline:

1-813-978-3700 • Mon-Fri 8am-8pm • Sat-Sun 10am - 6pm

Specifications and product details subject to change without notice.
© Copyright 2021, VOLT® Lighting, Lutz FL USA 33549 • All rights reserved.
customersupport@voltlighting.com • 813.978.3700



Package Contents

- A. (1) Glare Guard
- B. (1) Allen Key

- C. (1) Filter

Product Dimensions

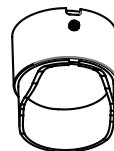
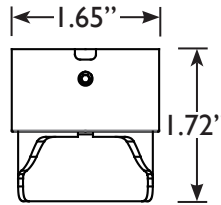
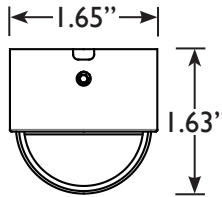
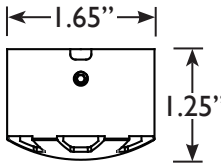
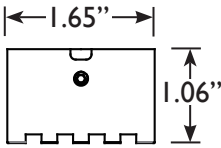
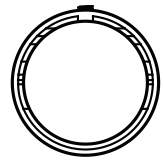
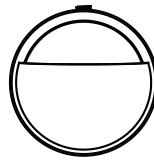
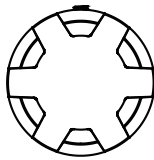
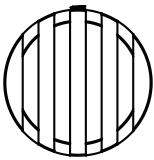

Option A

Option B

Option C

Option D

Glare Guard

1 Install Glare Guard

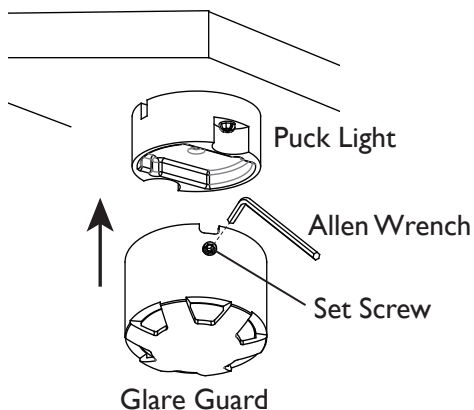

Place the glare guard onto the puck light. Secure it by tightening the set screw with the Allen wrench

Note: Glare guard shape varies according to the type you purchased.

Option A



Option B

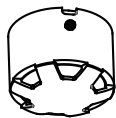

Option C



Option D



NOTE: Filter can be placed inside the glare guard to reduce light output.



Help Hotline:

1-813-978-3700 • Mon-Fri 8am-8pm • Sat-Sun 10am - 6pm

www.voltlighting.com

Specifications and product details subject to change without notice.
© Copyright 2021, VOLT® Lighting, Lutz FL USA 33549 • All rights reserved.
customersupport@voltlighting.com • 813.978.3700