

INSTALLATION INSTRUCTIONS



VOLT® Low Voltage Landscape Lighting

VOLT® Gentle Splash Flood Light

VFL-430-4-BBZ

Help Hotline:

1-813-978-3700 • Mon-Fri 8am-8pm • Sat-Sun 10am - 6pm (EST)

Specifications and product details subject to change without notice.
© Copyright 2019, VOLT® Lighting, Lutz FL USA 33549 • All rights reserved.
customersupport@voltlighting.com • 813.978.3700



! Important: Please Read Before Installation

This luminaire is intended for installation in accordance with local codes and the National Electric Code (NEC). Failure to adhere to these codes and instructions may result in serious injury, property damage and void the warranty.

These instructions do not intend to cover all variations in installation, operation maintenance or mounting situations.

1. Make sure that the power is turned OFF before installing or servicing this luminaire.
2. **WARNING:** risk of electrical shock. Install all luminaires 10 feet (3.05M) or more from pool, spa or fountain.
3. This luminaire is intended to be used only with a power supply (transformer) rated maximum of 300 watts (25 AMPS) at 15 volts.
4. Wiring connections must be made with UL listed wire connectors that are suitable for outdoor use.
5. Position the low voltage wire and wire connector so that it is located within 6 inches (15.2 cm) from a building structure, a luminaire or fitting.
6. The main low voltage cable is intended for shallow burial - less than 6 inches (152 mm)
7. If additional lengths of low voltage cable is required, please contact www.voltlighting.com or call 1-813-978-3700.

! IMPORTANT SAFETY INSTRUCTIONS

**INSTRUCTIONS PERTAINING TO A RISK OF FIRE, OR INJURY TO PERSONS
Lighted lamp is HOT!**

WARNING - To reduce the risk of FIRE OR INJURY TO PERSONS.

1. Turn off/unplug and allow to cool before replacing lamp.
2. Lamp gets HOT quickly! Contact only switch/plug when turning on.
3. Do not touch the hot lens, guard or enclosure.
4. Keep lamp away from materials that may burn.
5. Do not touch lamp at any time. Use a soft cloth. Oil from skin may damage lamp.
6. Do not operate the luminaire fitting with a missing or damage shield.

SAVE THESE INSTRUCTIONS

Package Contents

- A. (1) Stake
- B. (1) Luminaire

Product Dimensions

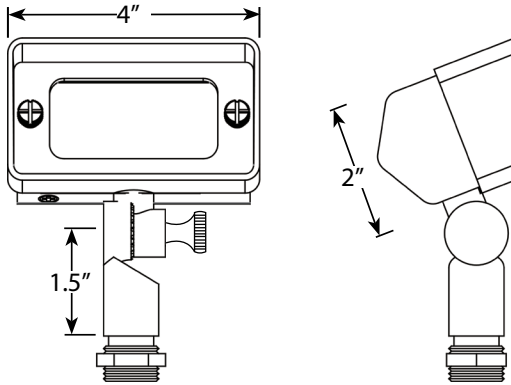

1 Install Stake

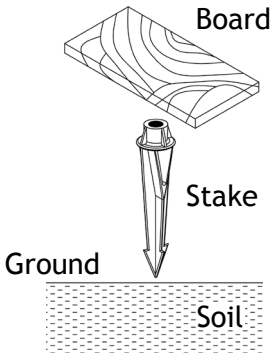

Determine the desired location for mounting the luminaire. Hammer the stake into the ground until the flange of stake is flush to grade. To avoid damage to the stake, place a board on top of stake while hammering.

NOTE: If the ground is hard and the stake is difficult to install, make a crosscut in ground using a flat shovel.



2 Remove Cover and Gasket with Lens

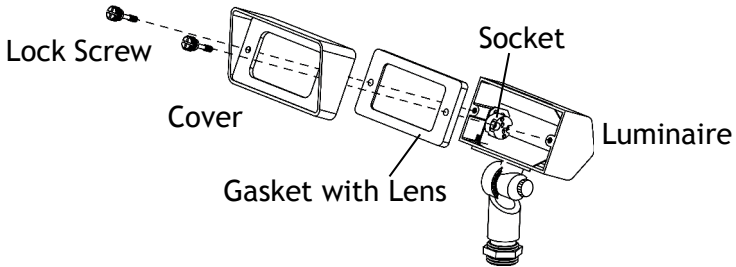

Loosen the lock screws and remove the cover and gasket with the lens from the luminaire to expose the socket.

3 Install Bulb

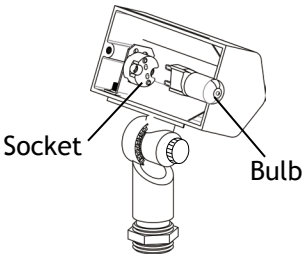

Insert the bulb with correct wattage and type marked on the luminaire label.

CAUTION: Do not exceed maximum wattage marked on luminaire label.

NOTE: DO NOT touch bulb with bare hands. Use soft cloth to handle lamp.

4 Install Gasket with Lens and Cover

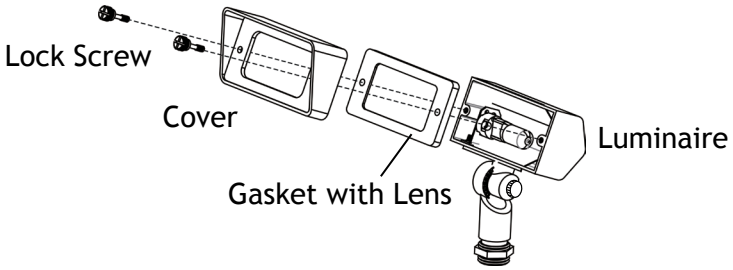

Decide which lens you would like to use with this fixture. Then install the gasket with your lens of choice back onto the luminaire and secure with the lock screws.

5 Install Luminaire to Stake

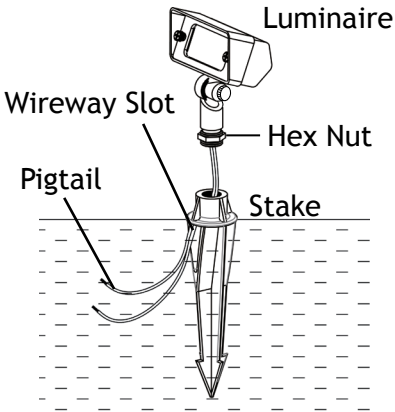

Clear away an area in the ground at the wireway slot on top of the stake. Lay the luminaire pigtail into the wireway slot and screw the fixture on to the stake. Tighten the hex nut on the luminaire against the stake and tighten until snug.



6 Wire Connection

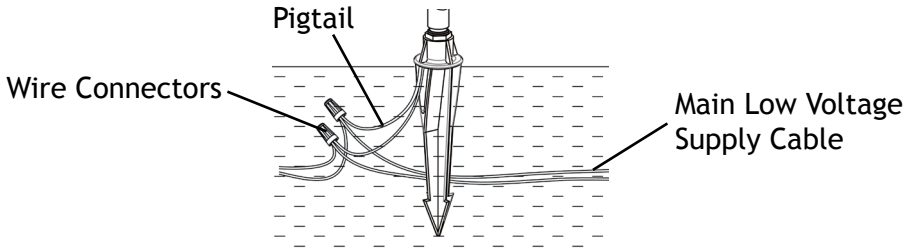

Strip both leads from the luminaire pigtail. Using two wire connectors (sold separately), connect the leads from the luminaire to the main supply cable leads.

Maintenance - Install/Replace Bulb

Please reverse Step 2 - Step 4 to expose the bulb and replace it with correct wattage and type marked on the luminaire label. Reinstall the gasket with the lens and cover.

IMPORTANT: Halogen lamps must be protected from moisture and dust at all times. Always reinstall gasket with lens and cover when removed.



Help Hotline:

1-813-978-3700 • Mon-Fri 8am-8pm • Sat-Sun 10am - 6pm (EST)

www.voltlighting.com

Specifications and product details subject to change without notice.
© Copyright 2019, VOLT® Lighting, Lutz FL USA 33549 • All rights reserved.
customersupport@voltlighting.com • 813.978.3700