

INSTALLATION & MAINTENANCE GUIDE

AMP[®] Lighting

AMP[®] Low Voltage Landscape Lighting

AMP[®] OrchardPro Path Light (Lamp - Ready)

APL-3018-B-BZ

Help Hotline:

1-813-978-3900 • Mon-Fri 9am-6pm (EST)

www.amplighting.com

! Important Safety Instructions: Read Before Installation

This fixture is intended for installation in accordance with local codes and the National Electric Code (NEC). Failure to adhere to these codes and instructions may result in serious injury, property damage and void the warranty.

These instructions do not intend to cover all variations in installation, operation maintenance or mounting situation.

1. Make sure that the power is turned OFF before installing or servicing this fixture.
2. Warning: this fixture is not intended to be installed within 10 feet [3 meters] of a pool, spa or fountain.
3. This fixture is intended to be used only with a power supply (transformer) rated maximum of 300 watts (25 AMPS) at 15 volts.
4. Underground Low Energy Cable must not be buried over 6" (15.2 cm) in order to connect to the main low voltage cable.
5. Wiring connections must be made with UL Listed wire connectors that is suitable for outdoor use.
6. Position the wire connector so that it is located within 6 inches (15.2 cm) from a building structure, a luminaire, or fitting.

! Important Safety Instructions: Read Before Installation

LIGHTED LAMP IS HOT!

WARNING - TO REDUCE THE RISK OF FIRE OR INJURY TO PERSONS.

1. Turn off/unplug and allow to cool before reducing lamp.
2. Lamp gets HOT quickly!
3. Do not touch the hot lens, guard or cowl.
4. Keep lamp away from materials that may burn.
5. Do not touch lamp at any time.
6. Use a soft cloth.
7. Oil from skin may damage lamp.
8. Do not operate the fixture with a damaged or missing lens or shield.

Package Contents

- | | |
|---------------------|-----------------|
| A. (1) Fixture Body | D. (1) LED Lamp |
| B. (1) Shade | E. (1) Diffuser |
| C. (1) Stake | |

Product Dimensions

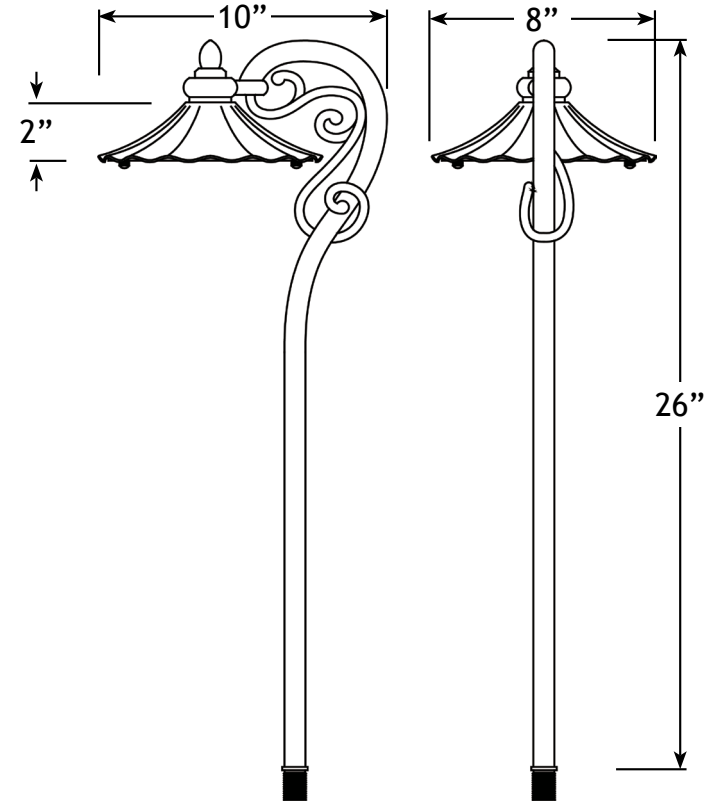

1 Install Stake

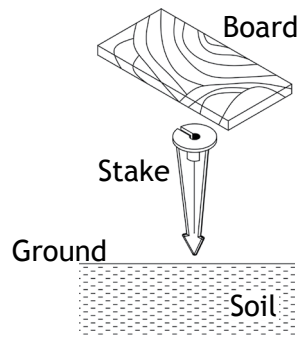

Determine the desired location for mounting the luminaire. Hammer the stake into the ground until flange of stake is flush to grade. To avoid damage to the stake, place a board on top of the stake while hammering.

NOTE: If the ground is hard and the stake is difficult to install, make a crosscut in the ground using a flat shovel.

2 Install Fixture Body to Stake

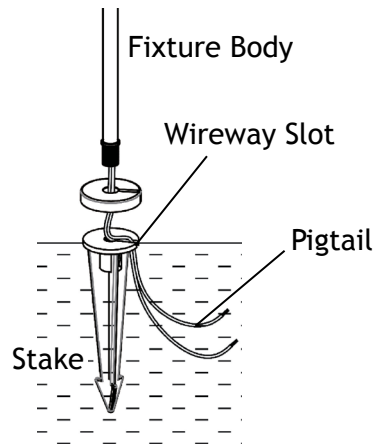

Clear away an area in the ground at the wireway slot on top of the stake. Lay the luminaire pigtail into the wireway slot and thread the coupler at the bottom end of the fixture body onto the stake. Tighten until snug to secure the base.

3 Wire Connection

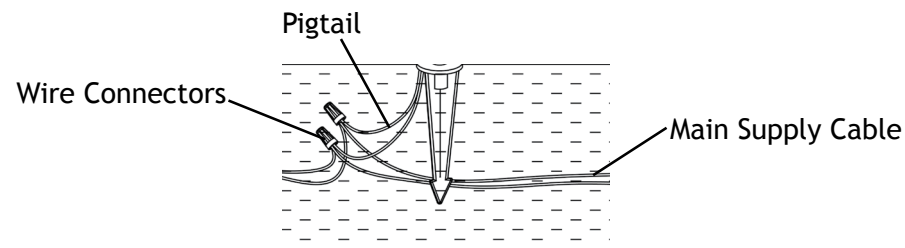

Strip both leads from the luminaire pigtail. Using two wire connectors (sold separately), connect the leads from the luminaire to the main supply cable leads.

4 Remove Dome Lens

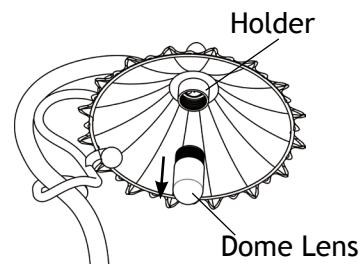

Loosen the dome lens from the holder to expose the socket.

5 Install Bulb

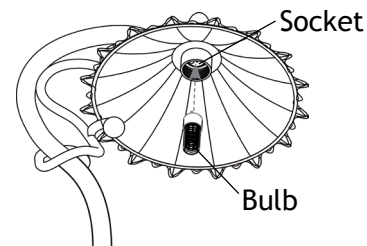

Insert bulb with the correct wattage and type marked on the fixture label.

CAUTION: Do not exceed maximum wattage marked on luminaire label.

NOTE: DO NOT touch bulb with bare hands. Use soft cloth to handle bulb.

6 Install Dome Lens

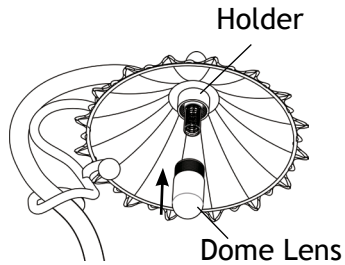

Thread the dome lens back onto the holder and hand tighten.

Install/Replace Bulb

Please reference Step 4 - Step 6 to expose the Bulb and replace it with the correct wattage and type marked on the fixture label. Reinstall Shield.

IMPORTANT: LED Bulb must be protected from moisture and dust at all times. Always reinstall shield when removed.

AMP[®] Lighting

Help Hotline:

1-813-978-3900 • Mon-Fri 9am-6pm (EST)

Specifications and product details subject to change without notice.
© Copyright 2019, AMP[®] Lighting, Lutz FL USA 33549 • All rights reserved.
customersupport@amplighting.com • 813.978.3900

www.amplighting.com