

INSTALLATION & MAINTENANCE GUIDE

AMP[®] Lighting

AMP[®] Low Voltage Landscape Lighting

AMP[®] KinglyPro Path Light (Lamp - Ready)

APL-3020-B-BZ

Help Hotline:

1-813-978-3900 • Mon-Fri 9am-6pm (EST)

www.amplighting.com

! Important Safety Instructions: Read Before Installation

This luminaire is intended for installation in accordance with local codes and the National Electric Code (NEC). Failure to adhere to these codes and instructions may result in serious injury, property damage and void the warranty.

These instructions do not intend to cover all variations in installation, operation maintenance or mounting situations.

1. Make sure that the power is turned OFF before installing or servicing this luminaire.
2. **WARNING:** risk of electrical shock. Install all luminaires 10 feet (3.05M) or more from pool, spa or fountain.
3. This luminaire is intended to be used only with a power supply (transformer) rated maximum of 300 watts (25 AMPS) at 15 volts.
4. Wiring connections must be made with UL listed wire connectors that are suitable for outdoor use.
5. Position the low voltage wire and wire connector so that it is located within 6 inches (15.2 cm) from a building structure, a luminaire or fitting.
6. The main low voltage cable is intended for shallow burial - less than 6 inches (152 mm)

! Important Safety Instructions

INSTRUCTIONS PERTAINING TO A RISK OF FIRE, OR INJURY TO PERSONS
Lighted lamp is HOT!

WARNING - To reduce the risk of FIRE OR INJURY TO PERSONS.

1. Turn off/unplug and allow to cool before replacing lamp.
2. Lamp gets **HOT** quickly! Contact only switch/plug when turning on.
3. Do not touch the hot lens, guard or enclosure.
4. Keep lamp away from materials that may burn.
5. Do not touch lamp at any time. Use a soft cloth. Oil from skin may damage lamp.
6. Do not operate the luminaire fitting with a missing or damage shield.

SAVE THESE INSTRUCTIONS

Package Contents

- | | |
|---------------------|--------------------|
| A. (1) Fixture Body | C. (1) Inner Shade |
| B. (1) Fixture Hood | D. (1) Stake |

Parts Required

- A. (1) LED Bulb

Product Dimensions

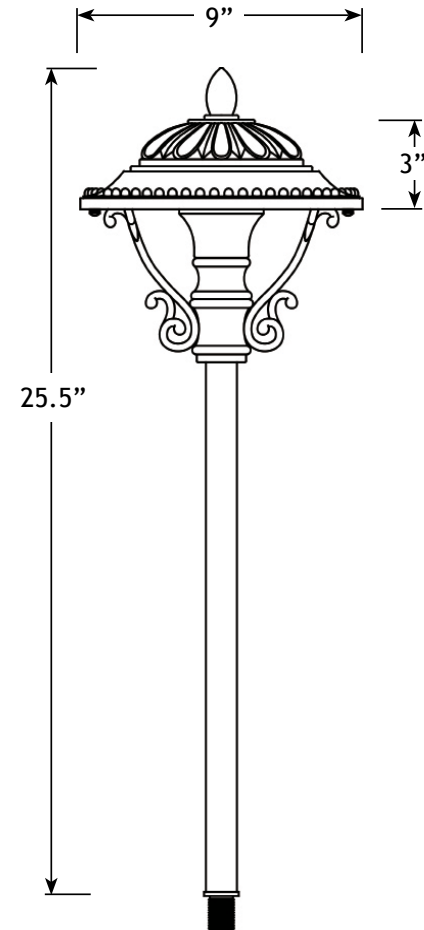

1 Install Stake

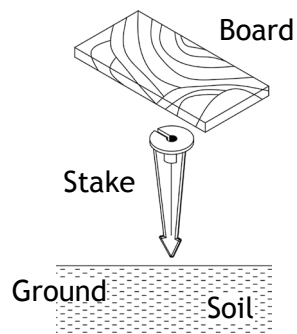

Determine the desired location for mounting the fixture. Hammer the stake into ground until flange of stake is flush to grade. To avoid damage to the stake, place a board on top of the stake while hammering.

NOTE: If the ground is hard and the stake is difficult to install, make a crosscut in ground using a flat shovel.

2 Remove Fixture Hood and Inner Shield

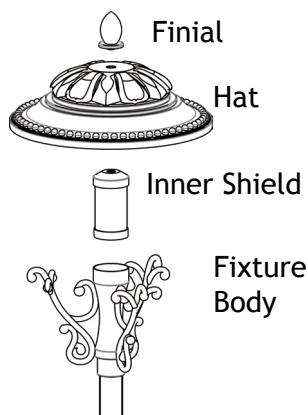

Remove the finial and the hat from the inner shield. Pull the inner shade off of the fixture body to expose the socket.

3 Install Lamp

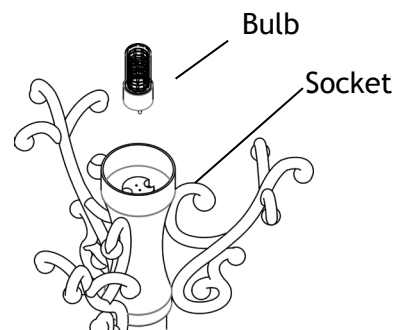

Insert the bulb with the correct wattage and type marked on the fixture label.

CAUTION: Do not exceed maximum wattage marked on luminaire label.

NOTE: DO NOT touch bulb with bare hands. Use a soft cloth to handle bulb.

4 Install Hat and Inner Shield

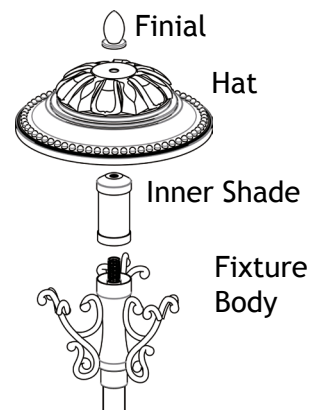

Push the inner shield onto the fixture body. Place the fixture hat back onto the inner shield and secure with the finial previously removed. Hand tighten.

5 Install Fixture Body to Stake

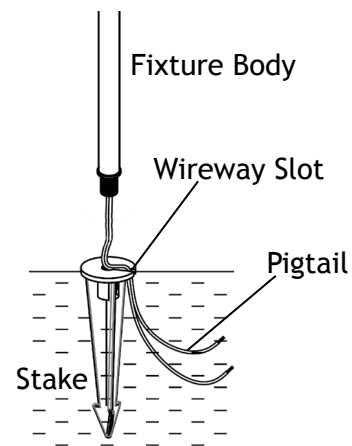

Clear away area in the ground at the wireway slot on top of the stake. Lay the luminaire pigtail into the wireway slot and thread the stem into the stake. Tighten to secure the base.

6 Wire Connection

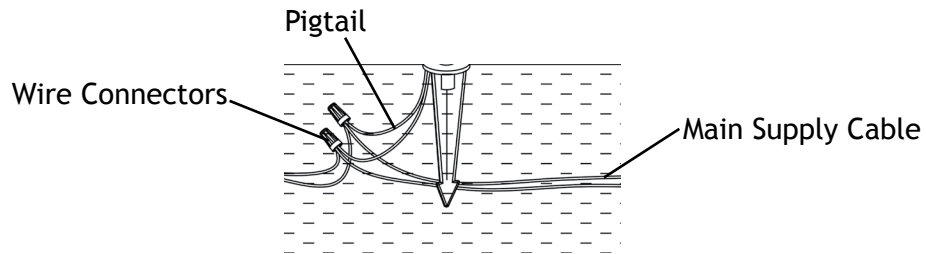

Strip both leads from the luminaire pigtail. Using two wire connectors (sold separately), connect the leads from the luminaire to the main low voltage supply cable leads.

Install/Replace Bulb

Please refer to Step 2 - Step 4 to expose the Lamp and replace it with the correct wattage and type marked on the fixture label.

IMPORTANT: LED Lamp must be protected from moisture and dust at all times. Always reinstall lens when removed.

AMP[®] Lighting

Help Hotline:

1-813-978-3900 • Mon-Fri 9am-6pm (EST)

Specifications and product details subject to change without notice.
© Copyright 2019, AMP[®] Lighting, Lutz FL USA 33549 • All rights reserved.
customersupport@amplighting.com • 813.978.3900

www.amplighting.com