

INSTALLATION INSTRUCTIONS



VOLT® Low Voltage Landscape Lighting

VOLT® All-Star Tommy Light

VAC-AL-GGT1-BBZ

Help Hotline:

1-813-978-3700 • Mon-Fri 8am-8pm • Sat-Sun 10am - 6pm (EST)

Specifications and product details subject to change without notice.
© Copyright 2019, VOLT® Lighting, Lutz FL USA 33549 • All rights reserved.
customersupport@voltlighting.com • 813.978.3700



! Important: Please Read Before Installation

This luminaire is intended for installation in accordance with local codes and the National Electric Code (NEC). Failure to adhere to these codes and instructions may result in serious injury, property damage, or void the warranty.

These instructions do not intend to cover all variations in installation, operation maintenance or mounting situations.

1. Make sure that the power is turned OFF before installing or servicing this luminaire.
2. **WARNING:** risk of electrical shock. Install all luminaires 10 feet (3.05M) or more from pool, spa or fountain.
3. This luminaire is intended to be used only with a power supply (transformer) rated maximum of 300 watts (25 AMPS) at 15 volts.
4. Wiring connections must be made with UL listed wire connectors that are suitable for outdoor use.
5. Position the low voltage wire and wire connector so that it is located within 6 inches (15.2 cm) from a building structure, a luminaire or fitting.
6. The main low voltage cable is intended for shallow burial - less than 6 inches (152 mm).
7. If additional lengths of low voltage cable is required, please contact www.voltlighting.com or call 1-813-978-3700.

! Important Safety Instructions

**INSTRUCTIONS PERTAINING TO A RISK OF FIRE, OR INJURY TO PERSONS
Lighted lamp is HOT!**

WARNING - To reduce the risk of FIRE OR INJURY TO PERSONS.

1. Turn off/unplug and allow to cool before replacing lamp.
2. Lamp gets HOT quickly! Contact only switch/plug when turning on.
3. Do not touch the hot lens, guard or enclosure.
4. Keep lamp away from materials that may burn.
5. Do not touch lamp at any time. Use a soft cloth. Oil from skin may damage lamp.
6. Do not operate the luminaire fitting with a missing or damaged shield.

SAVE THESE INSTRUCTIONS

www.voltlighting.com

Package Contents

A. (1) Fixture

Parts Required (sold separately)

A. (3) Self-tapping Screws

C. (1) LED MR16 Lamp

B. (3) Wall Anchors

Product Dimensions

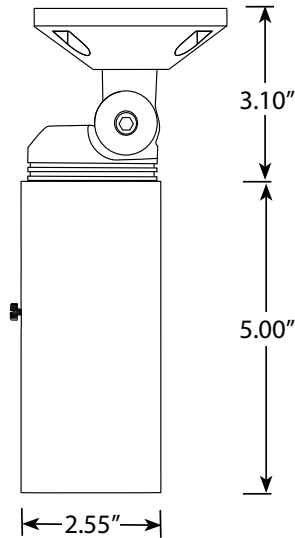

1 Remove Lens and Glare Guard

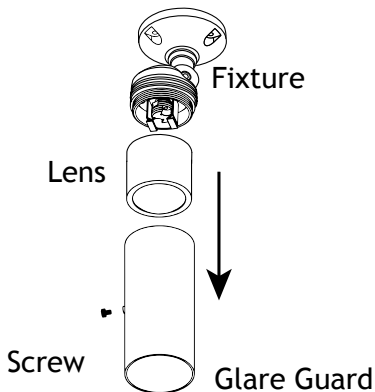

Use a screwdriver to loosen the set screw. Then, remove the glare guard from the lens. Next, remove the lens from the fixture.



2 Install Lamp

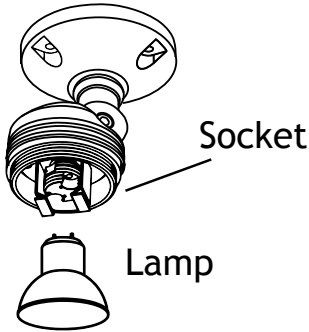

Insert the lamp with correct wattage and type marked on the fixture label.

CAUTION: Do not exceed maximum wattage marked on luminaire label.

NOTE: DO NOT touch lamp with bare hands. Use soft cloth to handle lamp.

3 Install Lens and Glare Guard

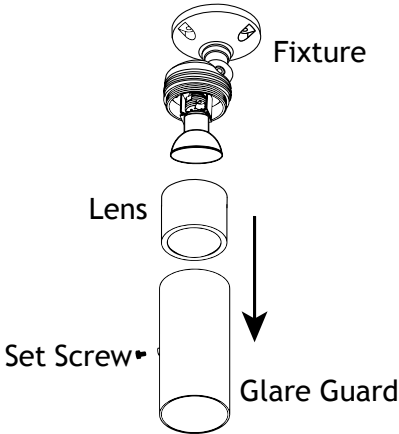

Place the lens over the lamp and thread onto the fixture. Tighten until snug. Attach the glare guard back onto the lens and secure with the set screw. Tighten until snug with a screwdriver.

4 Install Fixture

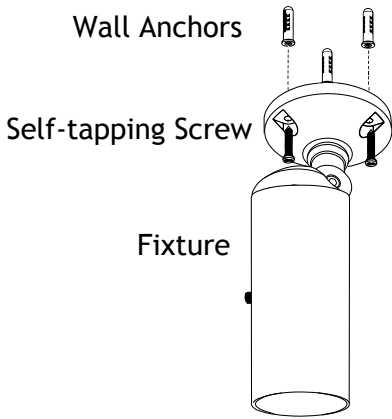

Determine your desired location for the fixture. Pass self-tapping screws through the holes on the surface mount. Thread self-tapping screws into the wall surface to secure the fixture.

***This fixture must be installed under an eave or overhang.**

NOTE: Wall anchors are required for brick walls or concrete walls. To determine locations for the wall anchors, place the surface mount onto your desired location and mark the points from the holes in the mount.

5 Wire Connections

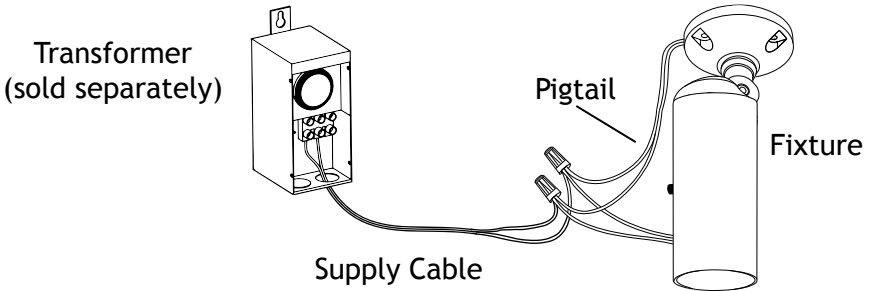

Strip both leads from the luminaire pigtail. Using two wire connectors (sold separately), connect the leads from the luminaire to the main supply cable leads.



6 Adjust Angle of Lamp

Knuckle
Adjustment

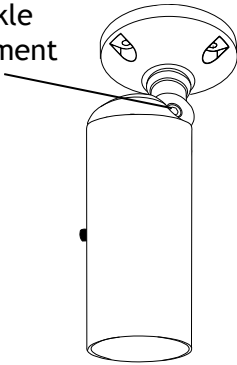

Loosen the knuckle and adjust the luminaire to your desired angle and then tighten adjustment screw.

Install/Replace Lamp

Loosen the set screw on the glare guard, then remove the glare guard and lens to expose the lamp. Replace it with the correct wattage and type marked on the fixture label. Finally, reinstall the lens and glare guard, then tighten the set screw.

IMPORTANT: Bulbs must be protected from moisture and dust at all times. Always reinstall lens and glare guards when removed.



Help Hotline:

1-813-978-3700 • Mon-Fri 8am-8pm • Sat-Sun 10am - 6pm (EST)

www.voltlighting.com

Specifications and product details subject to change without notice.

© Copyright 2019, VOLT® Lighting, Lutz, FL USA 33549 • All rights reserved
customersupport@voltlighting.com • 813.978.3700