

INSTALLATION & MAINTENANCE GUIDE

AMP[®] Lighting

AMP[®] Low Voltage Landscape Lighting
AMP[®] ControlPro 800 LED Spotlight
(Constant Output) AAL-1032

Help Hotline:

1-813-978-3900 • Mon-Fri 9am-6pm (EST)

———— www.amplighting.com ————



Important Safety Instructions: Read Before Installation

This fixture is intended for installation in accordance with local codes and the National Electric Code (NEC). Failure to adhere to these codes and instructions may result in serious injury, property damage and void the warranty.

These instructions do not intend to cover all variations in installation, operation maintenance or mounting situation.

1. Make sure that the power is turned OFF before installing or servicing this fixture.
2. Warning: this fixture is not intended to be installed within 10 feet [3 meters] of a pool, spa or fountain.
3. This fixture is intended to be used only with a power supply (transformer) rated maximum of 300 watts (25 AMPS) at 15 volts.
4. Underground Low Energy Cable must not be buried over 6" (15.2 cm) in order to connect to the main low voltage cable.
5. Wiring connections must be made with UL Listed wire connectors that are suitable for outdoor use.
6. Position the wire connector so that it is located within 6 inches (15.2 cm) from a building structure, a luminaire, or fitting.

Package Contents

- A. (1) Stake
- B. (1) Luminaire

Product Dimensions

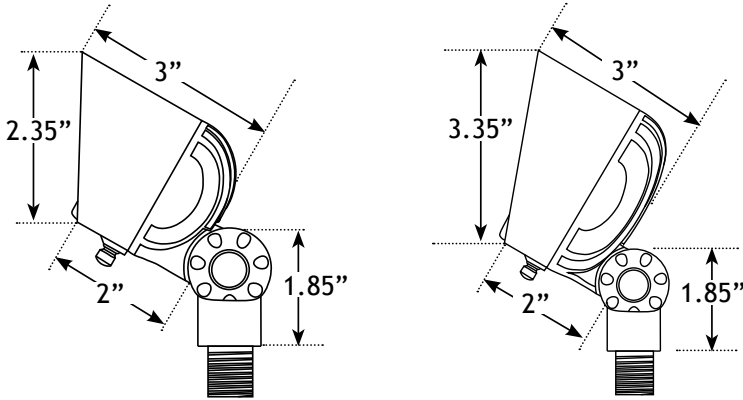

1 Install Stake

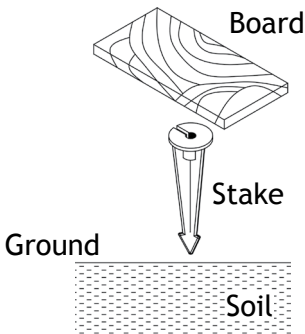

Determine the desired location for mounting the fixture. Hammer stake into the ground until flange of stake is flush to grade. To avoid damage to the stake, place a board on top of the stake while hammering.

NOTE: If the ground is hard and the stake is difficult to install, make a crosscut in the ground using a flat shovel.



2 Install Fixture to Stake

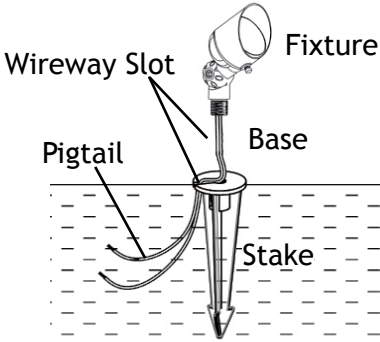

Clear away an area in the ground at the wireway slot on top of the stake. Align the wireway slot on the base and the stake. Lay the luminaire pigtail into the wireway slot and screw the fixture onto the stake. Tighten until snug to secure the base.

3 Wire Connection

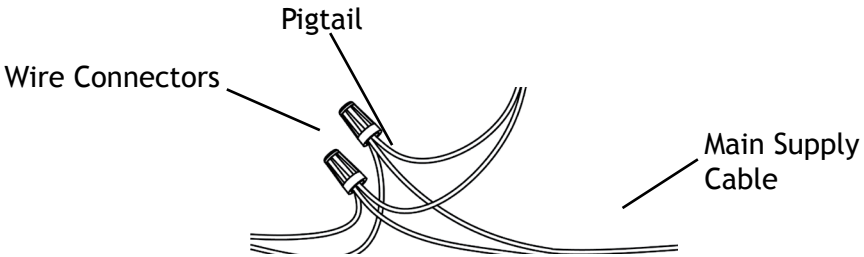

Strip both of the leads from the luminaire pigtail. Using two wire connectors (sold separately), connect the leads from luminaire to the main supply cable leads.

Install/Replace Optics

1 Remove Glare Guard

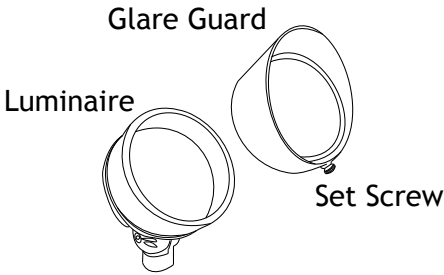

Unscrew the set screw and remove the glare guard from the luminaire.

2 Remove Outer Ring

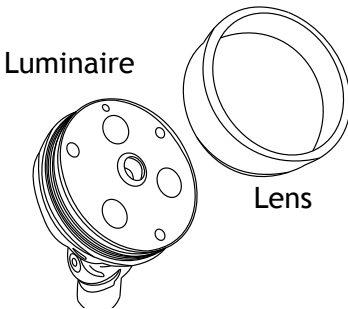

Unscrew the lens and remove it from the luminaire.

3 Replace Optic

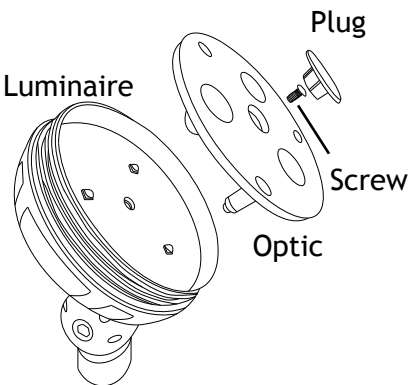

Remove the plug at the center of the optic. Unscrew the screw and remove the optic from the luminaire.

Put a new optic into the luminaire and reverse Step 3 - Step 1 to reinstall.

AMP[®] Lighting

Help Hotline:

1-813-978-3900 • Mon-Fri 9am-6pm (EST)

Specifications and product details subject to change without notice.
© Copyright 2019, AMP[®] Lighting, Lutz FL USA 33549 • All rights reserved.
customersupport@amplighting.com • 813.978.3900

www.amplighting.com

IS-AAL-1032-VER1.N.pdf