



VOLT® Low Voltage Landscape Lighting

VOLT® MR16 Single Source Bulbs

Product Description

Our Single Source LED MR16 Bulbs are a **CONFORMING SIZE**. Our LED Lightbulbs will fit any of our LED landscape lighting fixtures that require an MR16 bulb. Our lamps are specifically designed for landscape lighting and outdoor low voltage lighting.

Our high-performance “Single Source” LED lamps are specifically engineered to withstand the elements. Single source LEDs produce much crisper shadows since there is only one light source. Select the color temperature and beam angle that’s best suited for the application.

These Forever Bulbs® come with a Lifetime Warranty

Product Dimensions

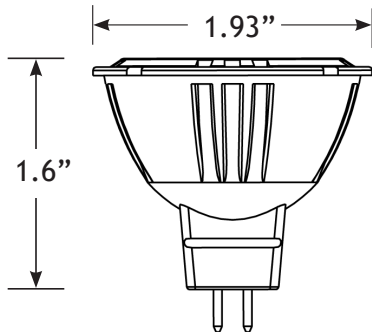

Specifications

- ▶ **Input Voltage, Frequency:** 11-16V, 50/60Hz AC
- ▶ **Lumen Output**
 - 2W (15W equiv.) Models: 150 lm
 - 3W (20W equiv.) Models: 300 lm
 - 5W (30W equiv.) Models: 400 lm
 - 7W (50W equiv.) Models: 500 lm
- ▶ **Correlated Color Temperature (CCT):** 2200K, 2700K, 3000K, 4000K
- ▶ **Color Rendering Index (CRI):** >80
- ▶ **Life:** 50,000 hours (L70)



Features & Benefits

- ▶ Replacements for:
 - 15W, 20W, 30W, and 50W Halogen MR16s
 - 15°, 38°, 60° and now 110° Beam Angles (**NOTE: NOT ALL MODELS ARE AVAILABLE IN ALL CCTs AND BEAM SPREADS**)
- ▶ Reduces energy consumption by about 75%
- ▶ Lasts up to 8 times longer than halogen lamps or 50,000 hours
- ▶ No warm-up time, instant-on with full light output and stable lamp to lamp color
- ▶ Wide input voltage 6-16VAC with decreased lumens under 10v
- ▶ CREE LED chips

Warranty

Residential: Lifetime Warranty
Commercial: 10-Year Warranty

Certifications



LISTED File #E366121



LISTED File #E366121